

Flat Bottom Pouch Capabilities

Available Features

- Terminated and taped side gussets
- Rounded corners
- One-way degassing valve
- Pocket Zipper
- PTC Zipper
- Side gusset Micro-Perforations

Web Requirements

- Main Web
- 3" Core
- Max Web Width - 1100mm
- Max OD - 600mm
- Gusset Web
- 3" Core
- Max Web Width - 350mm
- Max OD - 600mm



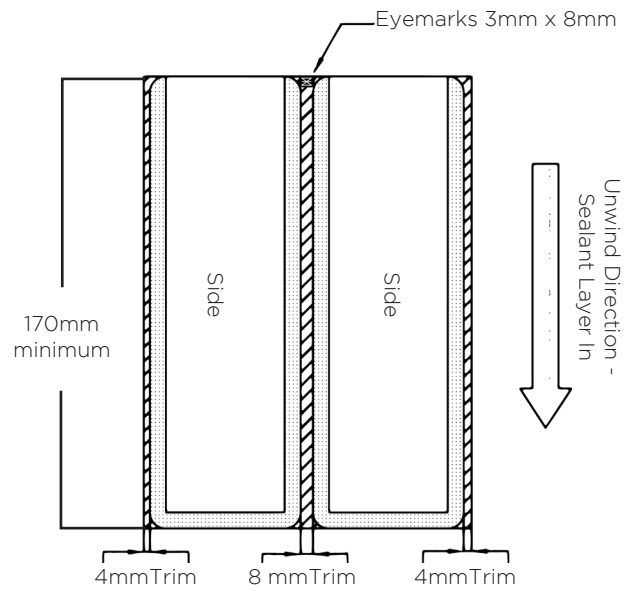
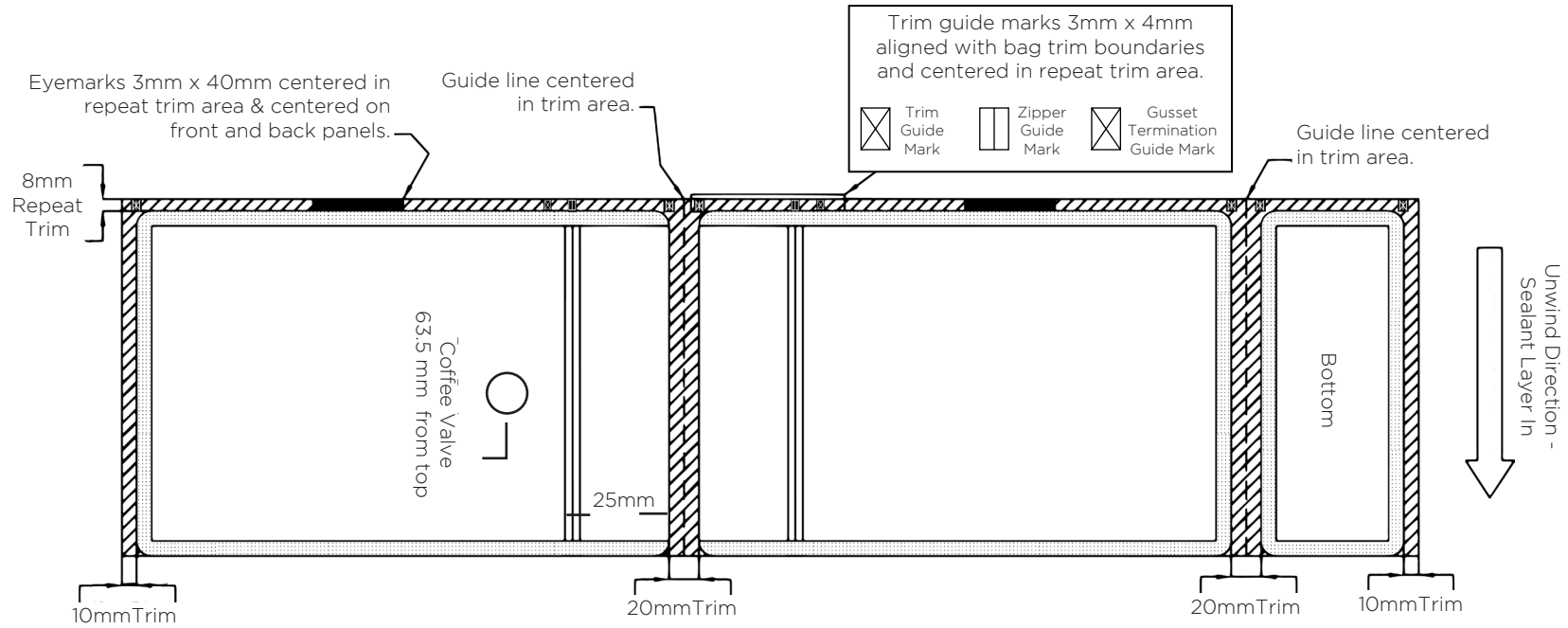

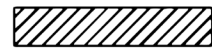
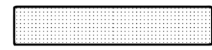
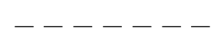

-  Trim Area
-  Seal Area
-  Fold Line

Terminated Gusset & PTC Zipper Closure

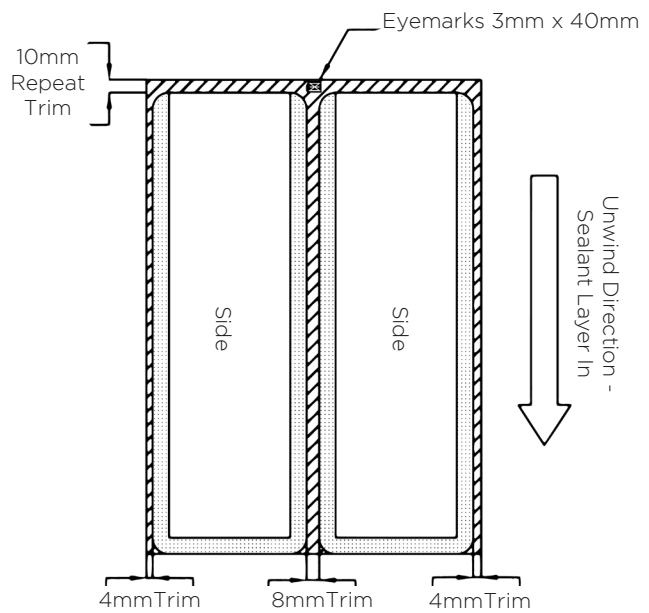
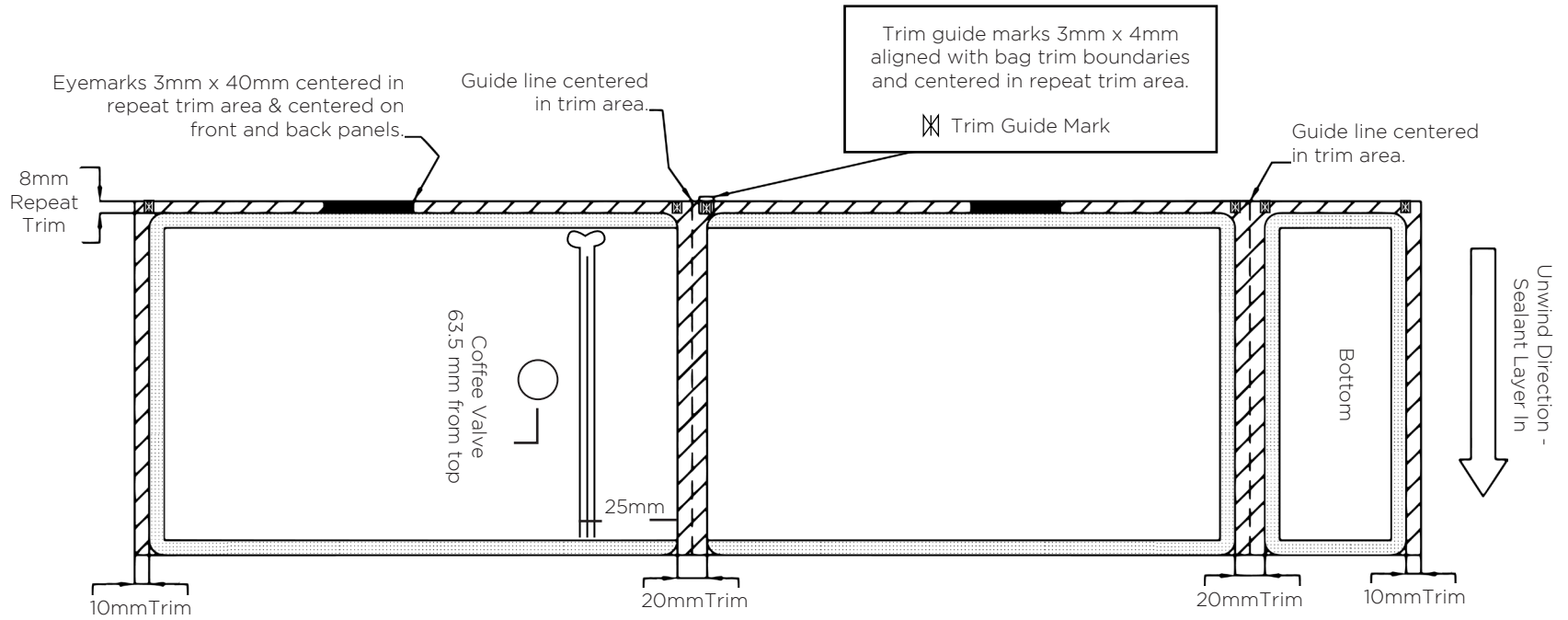

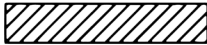
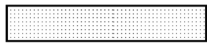

-  Trim Area
-  Seal Area
-  Fold Line

Non-Terminated Gusset

